

BALUSTRADE INSTALLATION - OPTION 1

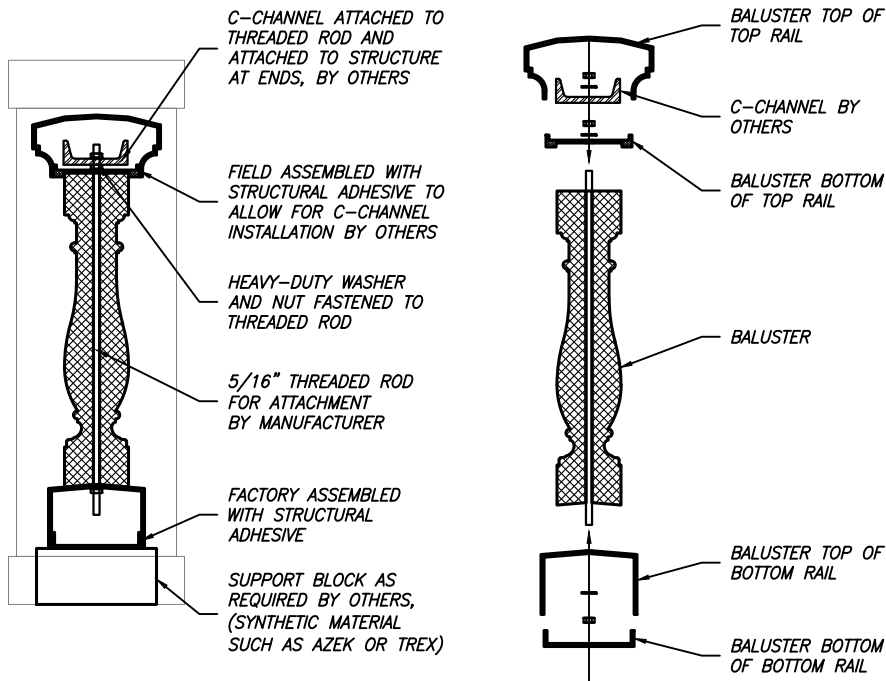

NOTE: C-CHANNEL COULD ALSO BE ADDED TO BOTTOM RAIL. C-CHANNEL MAY BE REQUIRED FOR RAIL LENGTHS LONGER THEN 12'

BALUSTRADE INSTALLATION - OPTION 2 (WITH C-CHANNEL)

BALUSTRADES

SHEET NO.

SD-01

2025

INSTALLATION



ARCHITECTURAL FIBERGLASS, INC.

8300 BESSEMER AVE., CLEVELAND, OHIO 44127-1839
 (216) 641-8300 - FAX:(216) 641-8150
 www.fiberglass-afi.com

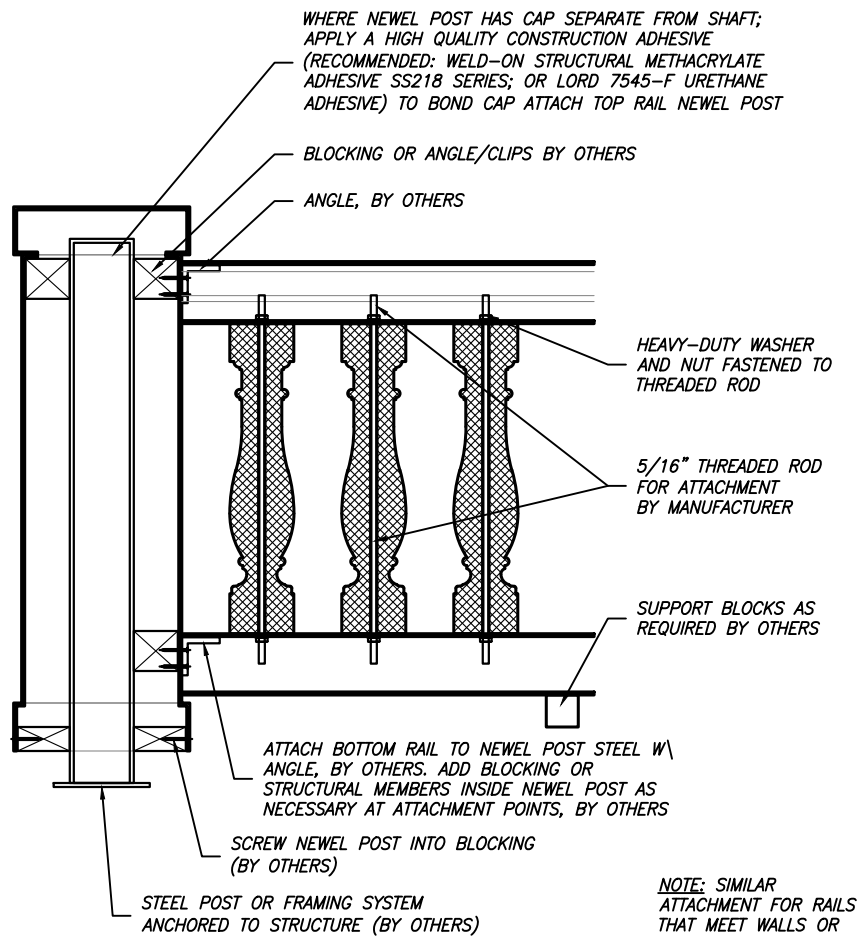

RAIL INSTALLATION - OPTION 1

BALUSTRADES

SHEET NO.

SD-02

2025

INSTALLATION



ARCHITECTURAL FIBERGLASS, INC.

8300 BESSEMER AVE., CLEVELAND, OHIO 44127-1839
 (216) 641-8300 - FAX:(216) 641-8150
 www.fiberglass-afi.com

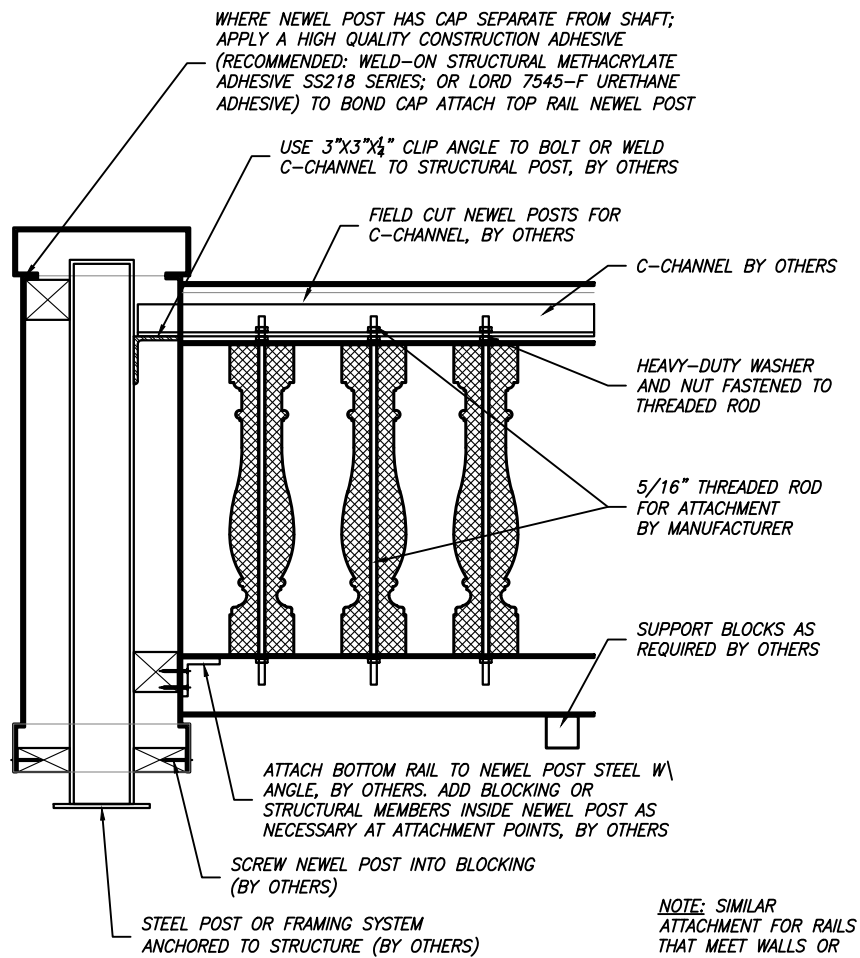

RAIL INSTALLATION - OPTION 2 (WITH C-CHANNEL)

BALUSTRADES

SHEET NO.

SD-03

2025

INSTALLATION



ARCHITECTURAL FIBERGLASS, INC.

8300 BESSEMER AVE., CLEVELAND, OHIO 44127-1839
(216) 641-8300 - FAX:(216) 641-8150
www.fiberglass-afi.com

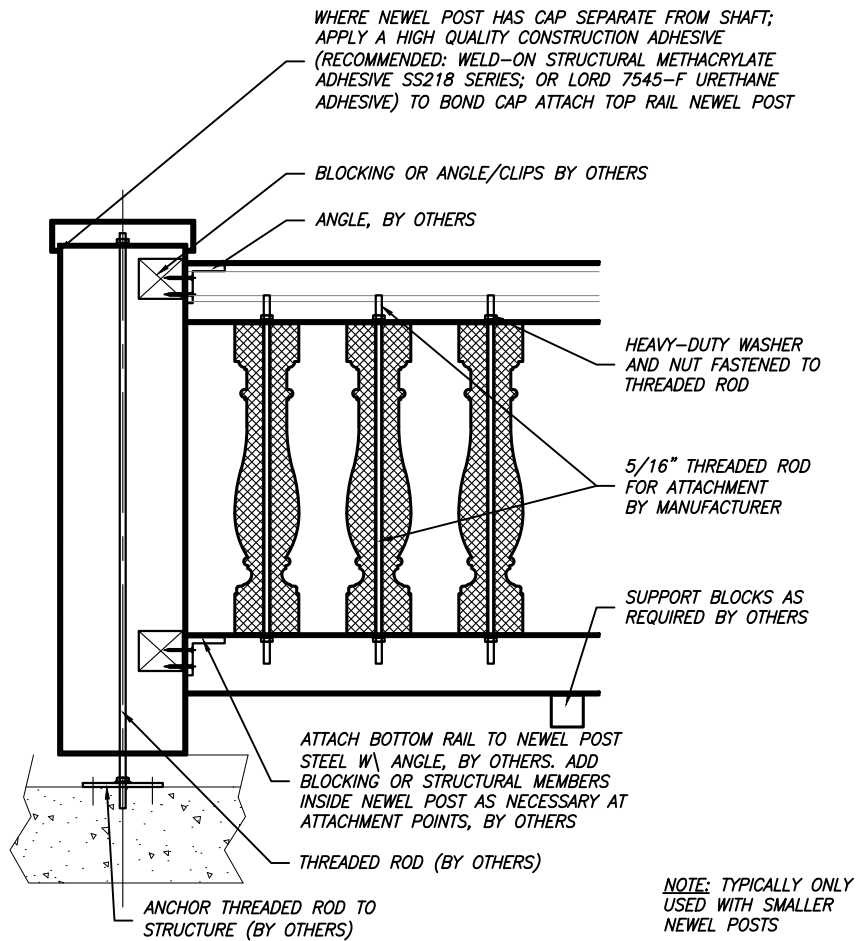

ALTERNATE NEWEL POST CONNECTION (DECORATIVE / NON-STRUCTURAL)

BALUSTRADES

SHEET NO.

SD-04

2025

INSTALLATION



ARCHITECTURAL FIBERGLASS, INC.

8300 BESSEMER AVE., CLEVELAND, OHIO 44127-1839
 (216) 641-8300 - FAX:(216) 641-8150
 www.fiberglass-afi.com

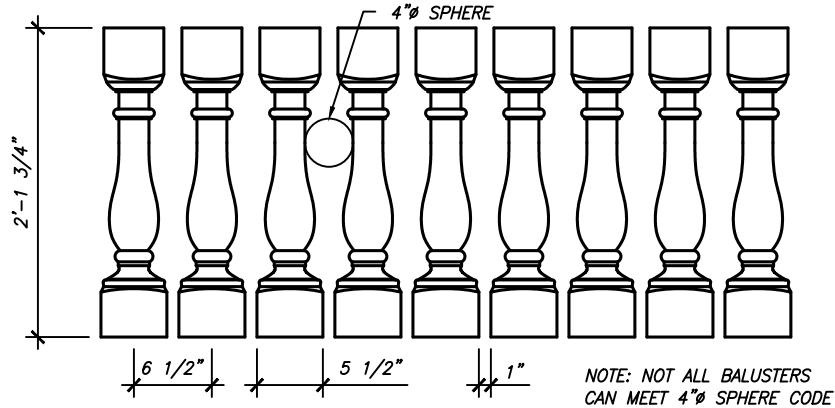

OPTION 1 - 4" SPHERE CODE SPACING

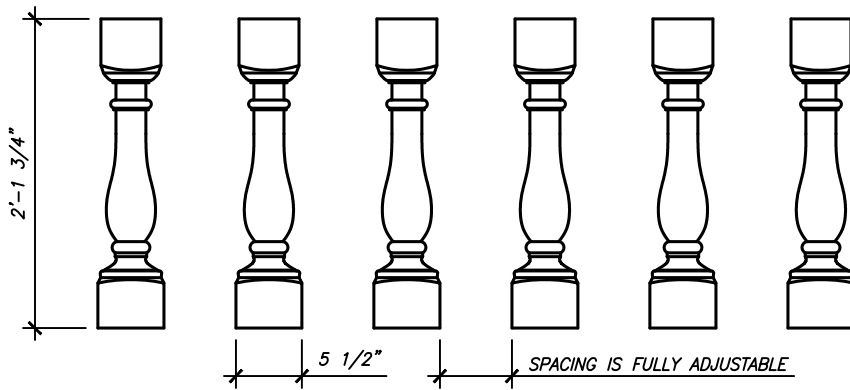

OPTION 2 - SPACING NOT TO CODE

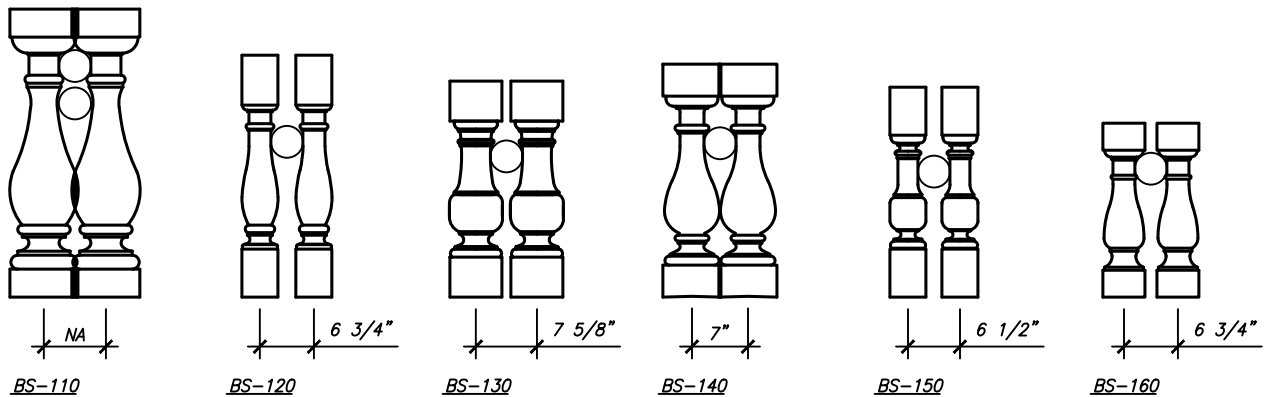

BALUSTRADES

SHEET NO.

SD-05

2025

INSTALLATION



ARCHITECTURAL FIBERGLASS, INC.

8300 BESSEMER AVE., CLEVELAND, OHIO 44127-1839
 (216) 641-8300 - FAX:(216) 641-8150
 www.fiberglass-afi.com

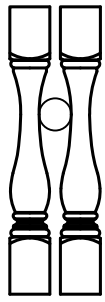

6 5/16"

BS-170

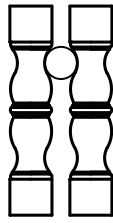

7 1/2"

BS-180

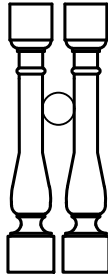

6 7/8"

BS-190

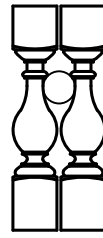

6"

BS-200



7"

BS-210

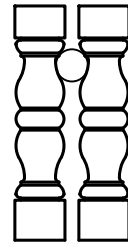

8"

BS-220

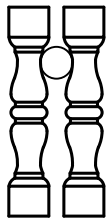

6 7/8"

BS-230

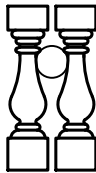

6"

BS-240

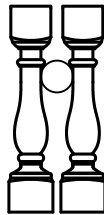

6 1/2"

BS-250



6 5/8"

BS-260

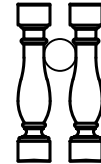

6 1/2"

BS-270

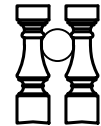

6 1/8"

BS-280

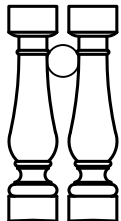

7 1/2"

BS-290

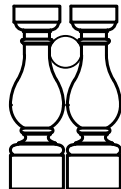

7 1/8"

BS-300

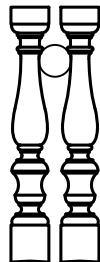

6 1/4"

BS-310

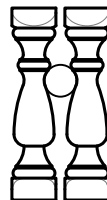

6 5/8"

BS-320

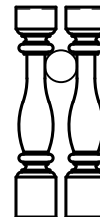

6 1/4"

BS-330



7"

BS-340

BALUSTRADES

SHEET NO.

SD-06

2025

INSTALLATION



ARCHITECTURAL FIBERGLASS, INC.

8300 BESSEMER AVE., CLEVELAND, OHIO 44127-1839
(216) 641-8300 - FAX:(216) 641-8150
www.fiberglass-afi.com

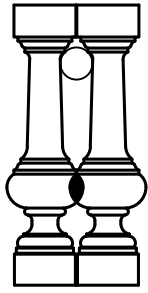

NA

BS-350

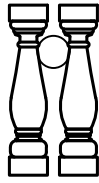

6 1/4"

BS-360

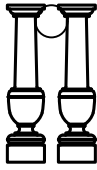

6 3/8"

BS-370



6"

BS-380

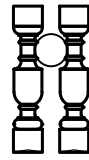

5 3/4"

BS-390

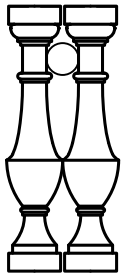

7"

BS-400

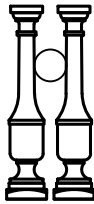

5 15/16"

BS-410

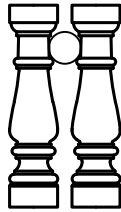

7 13/16"

BS-420



5 5/16"

BS-430

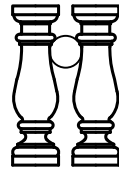

7 1/2"

BS-440

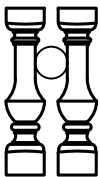

6 1/2"

BS-450

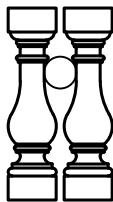

7"

BS-460

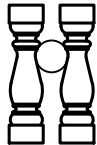

6 3/8"

BS-470

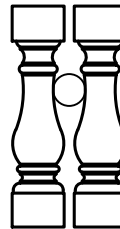

7 3/4"

BS-480



NA

BS-490

BALUSTRADES

SHEET NO.

SD-07

2025

INSTALLATION



ARCHITECTURAL FIBERGLASS, INC.

8300 BESSEMER AVE., CLEVELAND, OHIO 44127-1839
(216) 641-8300 - FAX:(216) 641-8150
www.fiberglass-afi.com